

Simon K9 K1 K1V K3 V8

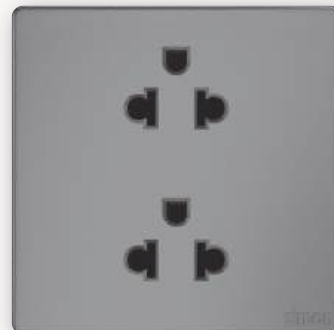

## SWITCHES & SOCKETS

Catalogue Retail Vietnam 2026

**simon**  
Since 1916 From Spain

# SIMON: TỪ NĂM 1916 TẠI BARCELONA



Tại Olot - 1920



Ông Arthur Simon và gia đình -1990



Nhà máy ở Calle Pare Roca, Olot - 1925



Nhà máy đồ sứ tại Sant Andreu, Barcelona - 1943



Gian hàng của IEP tại Feria de Madrid - 1949

1916

Ông Arturo Simon khởi nghiệp công ty ở Olot

1925

Ông Arturo Simon mở rộng hoạt động sản xuất và kinh doanh thiết bị điện

1942

Nhà máy sản xuất đồ sứ được mở

1957

Simon mua lại PME

1966

Simon mua lại IEP

1993

Ra mắt hệ thống điều khiển thông minh đầu tiên

1998

Simon bắt đầu quốc tế hóa

1999

Gia nhập thị trường Trung Quốc



1916

Bayonet bulb mount



1920-1930

851 "Extra" rotary switch



1956

Simon 24



1962

Simon 25



1973

Simon 36



1992

Simon 75



2013

Simon i7



Nhà máy Olot - 1975



Nhà máy Hayan, Trung Quốc - 1999



Sense - 2015



Simon Vox - 1998



Sân Vận Động Bắc Kinh, TQ - 2008



Nhà máy Simon Việt Nam - 2022

## 2006

Simon gia nhập thị trường Ấn Độ

## 2008

Simon được lựa chọn là nhà phân phối chính thức của Olympic tại Bắc Kinh

## 2015

Hệ thống cảm ứng mới ra đời

Hệ thống cảm ứng được đánh giá cao và nhận được một số giải thưởng quốc tế bởi nó kết hợp được 3 yếu tố vật lý, con người và môi trường một cách hài hòa

**Những giải thưởng quốc tế**

- Trong đó bộ đèn The Slim and Cool trong bộ sưu tập Fluvia đạt 5 giải thưởng quốc tế:
- iF Awards for Fluvia Slim luminaires
  - Red Dot Awards for the Slim and Cool Fluvia luminaires
  - Delta Awards in the selection category for Slim and Cool
  - Delta Awards for Detail 82
  - iF Gold Awards for Sense

## 2016

Simon toàn cầu kỉ niệm 100 năm

## 2020

Simon chính thức có trụ sở và xây dựng nhà máy tại Việt Nam.



2016

Simon E6



2020

Simon i6



2021

Simon K1



2021

Simon K3



2022

Simon S6



2026

Simon K9

# SIMON DESIGNING AWARDS



X Awards 2014 Simon 82 Detail



reddot award 2017 winner

Red Dot 2017 Simon 100



IF Gold Award 2018 Fluvia Loop



IF Design Award 2019 Simon 50E



reddot design award winner 2019



IF Design Award 2021



reddot winner 2021



IF Design Award 2022



reddot winner 2022

# DỰ ÁN SIMON



Marriott Auditorium Hotel, Madrid, Spain



National Stadium, Beijing, China



Grand Hyatt Bali, Indonesia



Kremlin, Moscow, Russia



Vinhomes Grand Park  
Phân khu The Origami, Việt Nam



Flamingo Đại Lải, Việt Nam



JW Marriott - Grand Marina Saigon,  
Việt Nam

## CÔNG TẮC Ổ CẮM



Series K1 .12



Series K3 .18



Series K9 .06



Series K1V .17



Series V8 .22

## THIẾT BỊ KHÁC



Tủ aptomat .30



Aptomat .31



Đế âm .32



Hộp chống thấm .32



Ổ cắm âm sàn .33



Quạt thông gió .34

### \* Ghi chú:

- Vui lòng liên hệ với Simon Việt Nam để biết thêm chi tiết về mã & màu sản phẩm.
- Tiêu chuẩn IEC.

### Remarks:

Please feel free to contact Simon Vietnam (local sales representatives) for product details. IEC Standard.

# Simon | K9



KIỆT TÁC GIAO HƯỞNG  
CHẠM NÉT TINH TẾ

# MÀU SẮC

Colours



Màu Trắng  
White



Màu Champagne  
Champagne



Màu Xám  
Grey

# MODULE LẮP GHÉP

Dimension

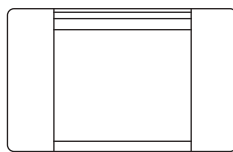

Khung

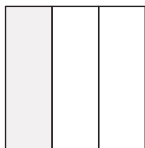

Size S  
C8 1/3

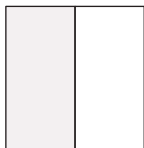

Size M  
C8 1/2

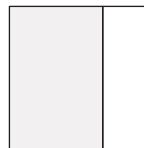

Size L  
C8 2/3



Size XL  
C8 1

## SERIES K9 - FULL SET



**BỘ CÔNG TẮC ĐƠN 1 CHIỀU SIZE XL**  
1 Gang XI 1 Way Switch

591011  **151.000**  
591011  -46 -61 **239.000**



**BỘ CÔNG TẮC ĐƠN 2 CHIỀU SIZE XL**  
1 Gang XI 2 Way Switch

591012  **198.000**  
591012  -46 -61 **286.000**



**BỘ CÔNG TẮC ĐÔI 1 CHIỀU SIZE M**  
2 Gang M 1 Way Switch

591021  **226.000**  
591021  -46 -61 **326.000**



**BỘ CÔNG TẮC ĐÔI 2 CHIỀU SIZE M**  
2 Gang M 2 Way Switch

591022  **325.000**  
591022  -46 -61 **425.000**



**BỘ CÔNG TẮC BA 1 CHIỀU SIZE S**  
3 Gang S 1 Way Switch

591031  **174.000**  
591031  -46 -61 **299.000**



**BỘ CÔNG TẮC BA 2 CHIỀU SIZE S**  
3 Gang S 2 Way Switch

591032  **312.000**  
591032  -46 -61 **438.000**



**BỘ 1 CÔNG TẮC 2 CHIỀU  
+ 2 CÔNG TẮC 1 CHIỀU SIZE S**  
1 Gang S 2 Way Switch & Two Gang S 1 Way Switch

591221  **220.000**  
591221  -46 -61 **345.000**



**BỘ 1 CÔNG TẮC 1 CHIỀU  
+ 2 CÔNG TẮC 2 CHIỀU SIZE S**  
1 Gang S 1 Way Switch & Two Gang S 2 Way Switch

591122  **266.000**  
591122  -46 -61 **392.000**



**BỘ 2 CÔNG TẮC 1 CHIỀU  
+ 1 HẠT CHE TRƠN SIZE S**  
2 Gang S 1 Way Switch & Blank Plate (S)

591110  **152.000**  
591110  -46 -61 **277.000**



**BỘ 2 CÔNG TẮC 2 CHIỀU  
+ 1 HẠT CHE TRƠN SIZE S**  
2 Gang S 2 Way Switch & Blank Plate (S)

591220  **244.000**  
591220  -46 -61 **370.000**



**BỘ 1 CÔNG TẮC 1 CHIỀU  
+ 2 HẠT CHE TRƠN SIZE S**  
1 Gang S 1 Way Switch & 2 Blank Plate (S)

591100  **130.000**  
591100  -46 -61 **255.000**



**BỘ 1 CÔNG TẮC 2 CHIỀU  
+ 2 HẠT CHE TRƠN SIZE S**  
1 Gang S 2 Way Switch & 2 Blank Plate (S)

591200  **176.000**  
591200  -46 -61 **301.000**



**BỘ CÔNG TẮC 20A CÓ ĐÈN  
+ 2 CÔNG TẮC 1 CHIỀU SIZE S**  
20A Switch With Indicator & Two Gang S 1 Way Switch

592023  **426.000**  
592023  -46 -61 **551.000**



**BỘ CÔNG TẮC 20A CÓ ĐÈN  
+ 2 NÚT CHE TRƠN**  
20A Switch With Indicator & 2 Blank Plate (S)

592200  **382.000**  
592200  -46 -61 **507.000**



**BỘ 2 CÔNG TẮC 2 CHIỀU SIZE S + HẠT ĐÈN**  
Two Gang S 2 Way Switch & Indicator Module

591033  **334.000**  
591033  -46 -61 **460.000**



**BỘ 1 Ổ ĐƠN 2 CHẤU + 1 HẠT ĐÈN  
+ 1 CÔNG TẮC 2 CHIỀU SIZE S**  
2 Pin Sockets & Indicator Module & 1 Gang S 2 Way Switch (S)

594132  **320.000**  
594132  -46 -61 **446.000**

## SERIES K9 - FULL SET



**BỘ 1 Ổ ĐƠN 2 CHẤU + 1 HẠT ĐÈN**  
+ 1 CÔNG TẮC 1 CHIỀU SIZE S  
2 Pin Sockets & Indicator Module & 1 Gang S 1 Way Switch (S)

594131  **274.000**  
594131  -46  -61 **399.000**



**BỘ 1 Ổ ĐƠN 2 CHẤU + 1 NÚT CHE TRƠN**  
+ 1 CÔNG TẮC 1 CHIỀU SIZE S  
2 Pin Sockets & Blank Plate & 1 Gang S 1 Way Switch (S)

594110  **184.000**  
594110  -46  -61 **309.000**



**BỘ 1 Ổ ĐƠN 2 CHẤU + 1 NÚT CHE TRƠN**  
+ 1 CÔNG TẮC 2 CHIỀU SIZE S  
2 Pin Sockets & Blank Plate & 1 Gang S 2 Way Switch (S)

594120  **230.000**  
594120  -46  -61 **355.000**



**BỘ 2 Ổ ĐƠN 2 CHẤU + 1 NÚT CHE TRƠN**  
Two 2 Pin Sockets & Blank Plate (S)

594200  **216.000**  
594200  -46  -61 **341.000**



**BỘ 2 Ổ ĐƠN 2 CHẤU**  
+ CÔNG TẮC 1 CHIỀU SIZE S  
Two 2 Pin Sockets & 1 Way Switch (S)

594101  **238.000**  
594101  -46  -61 **363.000**



**BỘ 2 Ổ ĐƠN 2 CHẤU**  
+ CÔNG TẮC 2 CHIỀU SIZE S  
Two 2 Pin Sockets & 2 Way Switch (S)

594102  **284.000**  
594102  -46  -61 **409.000**



**BỘ Ổ ĐƠN 2 CHẤU**  
+ 2 CÔNG TẮC ĐƠN 2 CHIỀU SIZE S  
2 Pin Sockets & Two 2 Way Switches (S)

594100  **298.000**  
594100  -46  -61 **424.000**



**BỘ BA Ổ CẮM 2 CHẤU**  
Three 2 Pin Sockets

594103  **270.000**  
594103  -46  -61 **395.000**

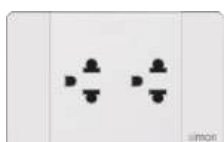

**BỘ Ổ CẮM ĐÔI 3 CHẤU THƯỜNG**  
Twin EU-US With Earth Socket

594201  **239.000**  
594201  -46  -61 **327.000**



**BỘ Ổ CẮM ĐÔI 3 CHẤU ĐA NĂNG**  
Twin EU-US Socket - Outlet

594202  **402.000**  
594202  -46  -61 **490.000**



**BỘ Ổ CẮM 3 CHẤU ĐA NĂNG SIZE L**  
+ CÔNG TẮC 1 CHIỀU SIZE S  
Multi - Standard Socket (L) & 1 Way Socket

594081  **274.000**  
594081  -46  -61 **374.000**



**BỘ Ổ CẮM 3 CHẤU ĐA NĂNG SIZE L**  
+ CÔNG TẮC 2 CHIỀU SIZE S  
Multi - Standard Socket (L) & 2 Way Socket (S)

594082  **320.000**  
594082  -46  -61 **420.000**



**BỘ 2 Ổ ĐƠN 3 CHẤU ĐA NĂNG**  
+ Ổ CẮM ĐƠN 2 CHẤU  
Multi - Standard Socket (L) & 2 Pin Socket

594080  **306.000**  
594080  -46  -61 **406.000**



**BỘ Ổ CẮM ĐƠN 2 CHẤU + Ổ CẮM TV**  
+ MẠNG CAT6  
2 Pin Socket & TV Outlet & Data Outlet CAT6

595302  **715.000**  
595302  -46  -61 **840.000**



**BỘ Ổ CẮM ĐƠN 2 CHẤU+CHIẾT ÁP QUẠT**  
Fan Regulator Switch & 2 Pin Socket

59E201  **798.000**  
59E201  -46  -61 **898.000**



**BỘ CÔNG TẮC CHUÔNG CỬA**  
Doorbell Switch

591301  **176.000**  
591301  -46  -61 **264.000**

## THIẾT KẾ ĐA DẠNG - TRẢI NGHIỆM ĐA CHIỀU



## SERIES K9 - MODULE



KHUNG VIÊN K9  
Frame K9

K9003N  39.000  
K9003N  -46  -61 88.000



HẠT CÔNG TẮC 1 CHIỀU SIZE XL  
1 Way Switch Module (XL)

K9103XL  112.000  
K9103XL  -46  -61 151.000



HẠT CÔNG TẮC 2 CHIỀU SIZE XL  
2 Way Switch Module (XL)

K9203XL  160.000  
K9203XL  -46  -61 198.000



HẠT CÔNG TẮC 1 CHIỀU SIZE M  
1 Way Switch Module (M)

K9103M  94.000  
K9103M  -46  -61 119.000

## SERIES K9 - MODULE



HẠT CÔNG TẮC 2 CHIỀU SIZE M  
2 Way Switch Module (M)

K9203M  143.000

K9203M  -46 -61 168.000



HẠT CÔNG TẮC 1 CHIỀU SIZE S  
1 Way Switch Module (S)

K9103S  45.000

K9103S  -46 -61 70.000



HẠT CÔNG TẮC 2 CHIỀU SIZE S  
2 Way Switch Module (S)

K9203S  91.000

K9203S  -46 -61 117.000



HẠT CÔNG TẮC 20A CÓ LED SIZE S  
20A Double Pole Switch Module (S)

K9104S  297.000

K9104S  -46 -61 322.000



NÚT CHE TRƠN SIZE S  
Blank Plate (S)

K9500S  23.000

K9500S  -46 -61 48.000



CÔNG TẮC CHUÔNG CỬA SIZE XL  
Doorbell Switch Module (XL)

K9505XL  138.000

K9505XL  -46 -61 176.000



Ổ CẮM ĐƠN 2 CHẤU SIZE S  
2 Pin Socket-Outlet Module (S)

K9412S  77.000

K9412S  -46 -61 102.000



Ổ CẮM ĐÔI 3 CHẤU THƯỜNG SIZE XL  
Twin EU- US With Earth Socket (XL)

K9424XL  200.000

K9424XL  -46 -61 239.000



Ổ CẮM ĐƠN 3 CHẤU ĐA NĂNG SIZE L  
Multi-Standard Socket-Outlet Module (L)

K9413L  190.000

K9413L  -46 -61 216.000



Ổ CẮM ĐÔI 3 CHẤU ĐA NĂNG SIZE XL  
Twin Multi-standard Socket Outlet Module (XL)

K9423XL  363.000

K9423XL  -46 -61 402.000



HẠT TV SIZE S  
TV Outlet Module (S)

K9501S  171.000

K9501S  -46 -61 196.000



HẠT MẠNG CAT6 SIZE S  
Data Outlet Cat6 Module (S)

K9506S  429.000

K9506S  -46 -61 454.000



HẠT ĐIỆN THOẠI SIZE S  
Telephone Outlet Module (S)

K9502S  169.000

K9502S  -46 -61 195.000



HẠT ĐÈN SIZE S  
LED Indicator Module (S)

K9503S  113.000

K9503S  -46 -61 139.000



HẠT CHIẾT ÁP ĐÈN SIZE L  
Dimmer Module (L)

K9509L  655.000

K9509L  -46 -61 680.000



HẠT CHIẾT ÁP QUẠT SIZE L  
Fan Regulator Module (L)

K9508L  682.000

K9508L  -46 -61 707.000

# Simon | K1 - K1V



VỀ ĐẸP  
Á ĐÔNG

# MÀU SẮC

Colours



Màu Trắng  
White



Màu Champagne  
Champagne

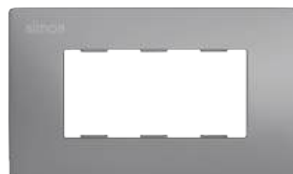

Màu Xám  
Grey

# MODULE LẮP GHÉP

Dimension

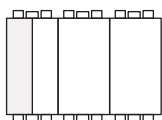

Size XS  
Cả 1/6



Size S  
Cả 1/3



Size M  
Cả 1/2

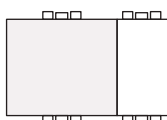

Size L  
Cả 2/3



Size XL  
Cả 1

## CÔNG TẮC Switches



HẠT CÔNG TẮC KÉP 1 CHIỀU SIZE S 16A  
Double switches 1 way (S)

K110S  99.000  
K110S  -46  -61 111.000



HẠT CÔNG TẮC 1 CHIỀU  
IN BIỂU TƯỢNG ĐÈN SIZE M 16A  
1 Way Switch Module (M)

K111M  119.000  
K111M  -46  -61 133.000



HẠT CÔNG TẮC 1 CHIỀU  
CÓ ĐÈN LED SIZE S 16A (Order)  
1 Way Switch Module with LED (S)

K111S  91.000  
K111S  -46  -61 103.000

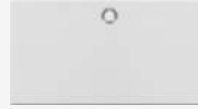

HẠT CÔNG TẮC 1 CHIỀU  
CÓ ĐÈN LED SIZE XL 16A (Order)  
1 Way Switch Module with LED (XL)

K111XL  105.000  
K111XL  -46  -61 121.000



HẠT CÔNG TẮC 1 CHIỀU  
CÓ NÚT ĐÈN TRANG TRÍ SIZE S 16A  
1 Way Switch Module (S)

K112S  40.000  
K112S  -46  -61 52.000



HẠT CÔNG TẮC 1 CHIỀU  
CÓ NÚT ĐÈN TRANG TRÍ SIZE XL 16A  
1 Way Switch Module (XL)

K112XL  52.000  
K112XL  -46  -61 68.000

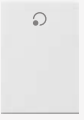

HẠT CÔNG TẮC 1 CHIỀU  
IN BIỂU TƯỢNG ĐÈN SIZE S 16A  
1 Way Switch Module (S)

K113S  35.000  
K113S  -46  -61 47.000

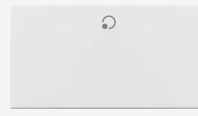

HẠT CÔNG TẮC 1 CHIỀU  
IN BIỂU TƯỢNG ĐÈN SIZE XL 16A  
1 Way Switch Module (XL)

K113XL  50.000  
K113XL  -46  -61 66.000

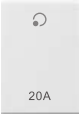

HẠT CÔNG TẮC 20A  
IN BIỂU TƯỢNG ĐÈN VÀ CHỮ SIZE S 20A  
20A Double Pole Switch Module (S)

K114S  205.000  
K114S  -46  -61 217.000

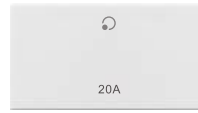

HẠT CÔNG TẮC 20A  
IN BIỂU TƯỢNG ĐÈN VÀ CHỮ SIZE XL 20A  
20A Double Pole Switch Module (XL)

K114XL  220.000  
K114XL  -46  -61 237.000



HẠT CÔNG TẮC ĐƠN 2 CHIỀU SIZE S 16A  
2 Way Switch Module (S)

K120S  61.000  
K120S  -46  -61 73.000



HẠT CÔNG TẮC ĐƠN 2 CHIỀU SIZE XL 16A  
2 Way Switch Module (XL)

K120XL  74.000  
K120XL  -46  -61 90.000



NÚT CHE TRƠN SIZE S  
Blank Plate (S)

K150S  19.000  
K150S  -46  -61 31.000



NÚT CHE TRƠN SIZE XS  
Blank Plate (XS)

K150XS  21.000  
K150XS  -46  -61 33.000



HẠT CÔNG TẮC TRUNG GIAN SIZE M 16A  
Intermediate Switch Module (M)

K131M  176.000  
K131M  -46  -61 190.000

## Ổ CẮM

## Socket-outlets



Ổ CẮM ĐƠN 2 CHẤU SIZE S 16A  
2 Pin Socket-Outlet Module (S)

K1412S  54.000

K1412S  -46  -61 66.000

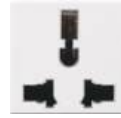

Ổ CẮM ĐƠN 3 CHẤU ĐA NĂNG SIZE M 10A  
Multi-Standard Socket-Outlet Module (M)

K1413M  107.000

K1413M  -46  -61 121.000



Ổ CẮM ĐÔI 3 CHẤU ĐA NĂNG SIZE XL 16A  
Twin EU-US Socket-Outlet

K1423XL  172.000

K1423XL  -46  -61 188.000

## HẠT TIVI, MẠNG, THOẠI &amp; ĐIỀU KHIỂN

## TV, Data, Tel, Control and Regulator



HẠT ĐÈN SIZE S MÀU XANH 1W  
LED Indicator - Green Color Module (S)

K1531S  108.000

K1531S  -46  -61 120.000



HẠT ĐÈN SIZE S MÀU ĐỎ 1W  
LED Indicator - Red Color Module (S)

K1532S  108.000

K1532S  -46  -61 120.000



HẠT ĐIỆN THOẠI SIZE S  
Telephone Outlet Module (S)

K154S  119.000

K154S  -46  -61 131.000



HẠT TIVI SIZE S  
TV Outlet Module (S)

K1551S  119.000

K1551S  -46  -61 131.000



HẠT MẠNG CAT 6 SIZE S  
Data Outlet Cat6 Module (S)

K1586S  289.000

K1586S  -46  -61 301.000



HẠT USB SIZE M 5V-2.4A  
Twin USB Charger Module (M)

K157S  975.000

K157S  -46  -61 989.000



HẠT CHIẾT ÁP ĐÈN SIZE L 1.8A-400W  
Dimmer Module (L)

K1591L  441.000

K1591L  -46  -61 457.000



HẠT CHIẾT ÁP QUẠT SIZE L 0.85A-200W  
Fan Regulator Module (L)

K1592L  475.000

K1592L  -46  -61 491.000



CÔNG TẮC THẺ TỪ 16A (ĐÈN SỢI ĐỐT),  
10A (ĐÈN LED), 6A (ĐỘNG CƠ)  
Keycard Switch Module

K1601  860.000

## MẶT VIÊN K1 Frames K1



### MẶT 1 LỖ SIZE S LẮP NGANG

1 Gang Plate (S)

K1001N  30.000

K1001N  -46  -61 67.000



### MẶT 2 LỖ SIZE S LẮP NGANG

2 Gangs Plate (S)

K1002N  30.000

K1002N  -46  -61 67.000



### MẶT 3 LỖ SIZE S LẮP NGANG

3 Gangs Plate (S)

K1003N  30.000

K1003N  -46  -61 67.000



### MẶT 6 LỖ SIZE S LẮP DỌC

6 Gangs Plate (S)

K1006D  55.000

K1006D  -46  -61 98.000



### MẶT APTOMAT TẾP ĐƠN LẮP DỌC

Blank Plate For Single Circuit Breaker

K1061D  32.000

K1061D  -46  -61 69.000



### MẶT APTOMAT TẾP ĐÔI LẮP DỌC

Blank Plate For Double Circuit Breaker

K1062D  32.000

K1062D  -46  -61 69.000



### MẶT APTOMAT KHỎI LẮP DỌC

Blank Plate For MCCB

K1063D  35.000

K1063D  -46  -61 73.000

## MẶT VIỀN K1V Frames K1V



MẶT 1 LỖ SIZE S LẮP NGANG CÓ GÂN VIỀN  
1 Gang Plate (S)

K1901	<input type="checkbox"/>	<b>31.000</b>
K1901	<input checked="" type="checkbox"/> -46 <input checked="" type="checkbox"/> -61	<b>68.000</b>



MẶT 2 LỖ SIZE S LẮP NGANG CÓ GÂN VIỀN  
2 Gangs Plate (S)

K1902	<input type="checkbox"/>	<b>31.000</b>
K1902	<input checked="" type="checkbox"/> -46 <input checked="" type="checkbox"/> -61	<b>68.000</b>



MẶT 3 LỖ SIZE S LẮP NGANG CÓ GÂN VIỀN  
3 Gangs Plate (S)

K1903	<input type="checkbox"/>	<b>31.000</b>
K1903	<input checked="" type="checkbox"/> -46 <input checked="" type="checkbox"/> -61	<b>68.000</b>



MẶT 6 LỖ SIZE S LẮP DỌC CÓ GÂN VIỀN  
6 Gangs Plate (S)

K1906	<input type="checkbox"/>	<b>55.000</b>
K1906	<input checked="" type="checkbox"/> -46 <input checked="" type="checkbox"/> -61	<b>98.000</b>



MẶT 1 LỖ SIZE M LẮP NGANG CÓ GÂN VIỀN  
1 Gang Plate (M)

K1911N	<input type="checkbox"/>	<b>32.000</b>
K1911N	<input checked="" type="checkbox"/> -46 <input checked="" type="checkbox"/> -61	<b>69.000</b>



MẶT APTOMAT TẾP ĐƠN LẮP DỌC CÓ GÂN VIỀN  
Blank Plate For Single Circuit Breaker

K1961	<input type="checkbox"/>	<b>35.000</b>
K1961	<input checked="" type="checkbox"/> -46 <input checked="" type="checkbox"/> -61	<b>73.000</b>



MẶT APTOMAT KHỐI LẮP DỌC CÓ GÂN VIỀN  
Blank Plate For MCCB

K1963	<input type="checkbox"/>	<b>37.000</b>
K1963	<input checked="" type="checkbox"/> -46 <input checked="" type="checkbox"/> -61	<b>75.000</b>

# Simon | K3



**UYỂN CHUYỂN**  
TRONG TỪNG ĐƯỜNG NÉT

# MÀU SẮC

Colours



Màu Trắng  
White



Màu Champagne  
Champagne



Màu Xám  
Grey

# ĐA DẠNG KHUNG VIÊN

A Variety Of Border Frames

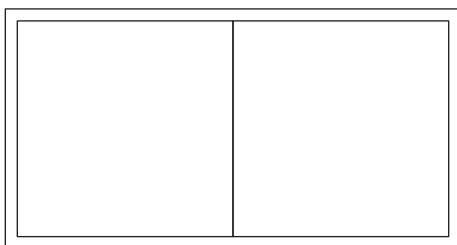

Khung đôi  
2 Gang frame

## CÔNG TẮC Switches



**BỘ CÔNG TẮC ĐƠN 1 CHIỀU 16A**  
1 Gang 1 Way Switch

571011  **105.000**  
571011  -46  -61 **150.000**



**BỘ CÔNG TẮC ĐƠN 2 CHIỀU 16A**  
1 Gang 2 Way Switch

571012  **129.000**  
571012  -46  -61 **174.000**



**BỘ CÔNG TẮC 1 CHIỀU 20A**  
20A Double Pole Switch

572023  **441.000**  
572023  -46  -61 **486.000**



**BỘ CÔNG TẮC ĐƠN TRUNG GIAN**  
1 Gang Intermediate Switch

571026  **213.000**  
571026  -46  -61 **259.000**



**BỘ CÔNG TẮC ĐÔI 1 CHIỀU 16A**  
2 Gang 1 Way Switch

571021  **163.000**  
571021  -46  -61 **208.000**



**BỘ CÔNG TẮC ĐÔI 2 CHIỀU 16A**  
2 Gang 2 Way Switch

571022  **205.000**  
571022  -46  -61 **250.000**



**BỘ CÔNG TẮC BA 1 CHIỀU 16A**  
3 Gang 1 Way Switch

571031  **213.000**  
571031  -46  -61 **259.000**



**BỘ CÔNG TẮC BA 2 CHIỀU 16A**  
3 Gang 2 Way Switch

571032  **265.000**  
571032  -46  -61 **310.000**



**BỘ CÔNG TẮC BỐN 1 CHIỀU 10A**  
4 Gang 1 Way Switch

571041  **278.000**  
571041  -46  -61 **323.000**



**BỘ CÔNG TẮC BỐN 2 CHIỀU 10A**  
4 Gang 2 Way Switch

571042  **354.000**  
571042  -46  -61 **399.000**



**BỘ CÔNG TẮC CHUÔNG CỬA**  
Doorbell Switch

576301  **138.000**  
576301  -46  -61 **183.000**



**BỘ MẶT CHE TRƠN**  
Blank Plate

571000  **46.000**  
571000  -46  -61 **91.000**

## Ổ CẮM

## Socket-outlets



**BỘ Ổ CẮM ĐÔI 2 CHẤU 16A**  
Twin 2 Pole Socket

571072  **186.000**

571072  -46  -61 **231.000**

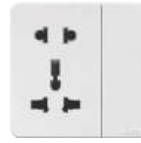

**BỘ Ổ CẮM 2 CHẤU + 3 CHẤU ĐA NĂNG  
+ CÔNG TẮC (16A/10A)**  
2 Pin Socket & Multi-Standard Socket & Switch

571080  **246.000**

571080  -46  -61 **292.000**

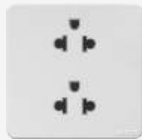

**BỘ Ổ CẮM ĐÔI 3 CHẤU 16A**  
Twin EU- US With Earth Socket

571287  **281.000**

571287  -46  -61 **326.000**



**BỘ Ổ CẮM ĐƠN 3 CHẤU 16A**  
Single EU- US With Earth Socket

571087  **228.000**

571087  -46  -61 **273.000**

## HẠT TIVI, MẠNG, THỌẠI &amp; ĐIỀU KHIỂN

## TV, Data, Tel, Control and Regulator



**BỘ Ổ CẮM TIVI ĐƠN**  
Tivi Outlet

575111  **185.000**

575111  -46  -61 **230.000**



**BỘ Ổ CẮM TIVI ĐƠN CHUẨN F**  
TV Outlet With F Connector

575114  **206.000**

575114  -46  -61 **251.000**



**BỘ Ổ CẮM ĐIỆN THỌẠI ĐƠN**  
Telephone Outlet

575214  **152.000**

575214  -46  -61 **197.000**



**BỘ Ổ CẮM MẠNG ĐƠN CAT6**  
Data Outlet Cat6

575218  **235.000**

575218  -46  -61 **281.000**



**BỘ Ổ CẮM MẠNG ĐÔI CAT6**  
Twin Data Outlet Cat6

575228  **270.000**

575228  -46  -61 **315.000**



**BỘ Ổ CẮM ĐIỆN THỌẠI + MẠNG CAT6**  
Telephone and Data Outlet Cat6

575229  **329.000**

575229  -46  -61 **374.000**



**BỘ Ổ CẮM TIVI + MẠNG CAT6**  
Tivi & Data Outlet (Cat6)

575302  **333.000**

575302  -46  -61 **378.000**



**BỘ CHIẾT ÁP ĐÈN 0.85A-200W**  
Dimmer Switch

57E101  **618.000**

57E101  -46  -61 **663.000**



**BỘ CHIẾT ÁP QUẠT 0.85A-200W**  
Fan Regulator Switch

57E201  **582.000**

57E201  -46  -61 **627.000**



**KHUNG VIÊN ĐÔI**  
2 Gang Frame (86mm x172mm)

570620  **45.000**

570620  -46  -61 **80.000**

# Simon | V8



SANG TRỌNG  
TINH TẾ

# MẶT HẠT NHIỀU MÀU SẮC

Colours



Màu Trắng/ Màu Xám/ Màu Champagne/ Màu Đá  
White/ Grey/ Champagne/ Stone

# ĐA DẠNG KHUNG VIÊN

A Variety Of Border Frames

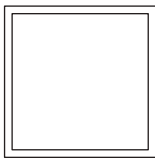

Khung đơn  
1 Gang frame

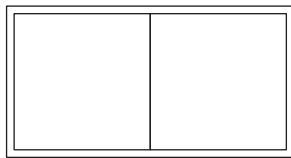

Khung đôi  
2 Gang frame

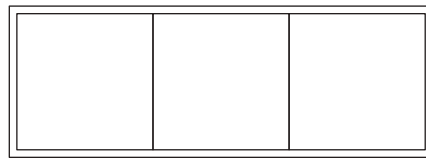

Khung ba  
3 Gang frame

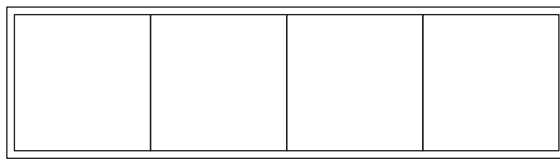

Khung bốn  
4 Gang frame

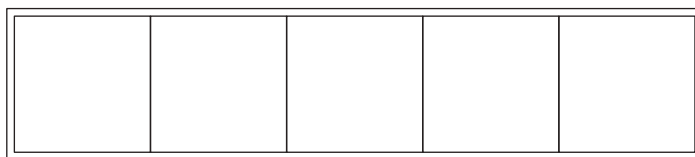

Khung năm  
5 Gang frame

## CÔNG TẮC Switches



### MODULE CÔNG TẮC ĐƠN 16A 1 CHIỀU

1 Gang 1 Way Switch Module (16AX 250V)

80101  174.000  
80101  -56  -26 217.000



### MODULE CÔNG TẮC ĐƠN 16A 1 CHIỀU CÓ ĐÈN LED

1 Gang 1 Way Switch Module with LED Indicator (16AX 250V)

80104  255.000  
80104  -56  -26 298.000



### MODULE CÔNG TẮC ĐƠN 16A 2 CHIỀU

1 Gang 2 Way Switch Module (16AX 250V)

80201  197.000  
80201  -56  -26 240.000



### MODULE CÔNG TẮC TRUNG GIAN

1 Gang Intermediate Switch Module (16AX 250V)

80397H  304.000  
80397H  -56  -26 347.000



### MODULE CÔNG TẮC ĐƠN 20A 2 CỰC, 1 CHIỀU CÓ ĐÈN LED ĐỎ

20A 2 Pole 1 Way Switch with Red LED Module (20AX 250V)

80203  600.000  
80203  -56  -26 642.000



### MODULE CÔNG TẮC ĐƠN 20A 2 CỰC, 2 CHIỀU CÓ ĐÈN LED ĐỎ

20A 2 Pole 2 Way Switch with Red LED Module (20AX 250V)

80204  649.000  
80204  -56  -26 692.000



### MODULE CÔNG TẮC ĐƠN 32A 2 CỰC, 1 CHIỀU CÓ ĐÈN LED ĐỎ

32A 2 Pole 1 Way Switch with Red LED Module (32AX 250V)

80323  613.000  
80323  -56  -26 656.000



### MODULE CÔNG TẮC ĐƠN 32A 2 CỰC, 2 CHIỀU CÓ ĐÈN LED ĐỎ

32A 2 Pole 2 Way Switch with Red LED Module (32AX 250V)

80324  649.000  
80324  -56  -26 692.000



### MODULE CÔNG TẮC ĐÔI 16A 1 CHIỀU CÓ ĐÈN LED

2 Gang 1 Way Switch Module with LED Indicator (16AX 250V)

80396  372.000  
80396  -56  -26 415.000



### MODULE CÔNG TẮC ĐÔI 16A 2 CHIỀU

2 Gang 2 Way Switch Module (16AX 250V)

80397  268.000  
80397  -56  -26 311.000



### MODULE CÔNG TẮC ĐÔI 16A 1 CHIỀU

2 Gang 1 Way Switch Module (16AX 250V)

80398  251.000  
80398  -56  -26 294.000



### MODULE CÔNG TẮC BA 16A 1 CHIỀU CÓ ĐÈN LED

3 Gang 1 Way Switch Module with LED (16AX 250V)

80370  506.000  
80370  -56  -26 549.000



### MODULE CÔNG TẮC BA 16A 1 CHIỀU

3 Gang 1 Way Switch Module (16AX 250V)

80371  317.000  
80371  -56  -26 360.000



### MODULE CÔNG TẮC BA 16A 2 CHIỀU

3 Gang 2 Way Switch Module (16AX 250V)

80372  351.000  
80372  -56  -26 394.000



### MODULE NÚT CHE TRƠN

Blank Plate Module

80800  136.000  
80800  -56  -26 179.000

## CÔNG TẮC NHẤN NHÀ Push Button Switches



### MODULE NÚT NHẤN ĐƠN

1 Gang Push-Button Switch Module (16A 250V)

80101F  **195.000**

80101F  -56  -26 **238.000**



### MODULE NÚT NHẤN ĐƠN CÓ ĐÈN LED

1 Gang Push-Button With LED Indicator Module (16A 250V)

80104F  **265.000**

80104F  -56  -26 **308.000**



### MODULE NÚT NHẤN ĐÔI

2 Gang Push-Button Switch Module (16A 250V)

80398F  **240.000**

80398F  -56  -26 **283.000**



### MODULE NÚT NHẤN ĐÔI CÓ ĐÈN LED

2 Gang Push-Button Switch Module with LED (16A 250V)

80396F  **367.000**

80396F  -56  -26 **410.000**



### MODULE NÚT NHẤN BA

3 Gang Push-Button Switch Module (16A 250V)

80371F  **329.000**

80371F  -56  -26 **372.000**



### MODULE NÚT NHẤN BA CÓ ĐÈN LED

3 Gang Push-Button Switch Module with LED (16A 250V)

80370F  **509.000**

80370F  -56  -26 **552.000**



### MODULE NÚT NHẤN CHUÔNG CỬA

Doorbell Switch Module (16A 250V)

80150  **178.000**

80150  -56  -26 **221.000**

## Ổ CẮM Socket-outlets



### MODULE Ổ CẮM 3 CHẤU ĐA NĂNG

Multi-standard Socket Module (13A 250V)

80430  **234.000**

80430  -56  -26 **277.000**



### MODULE Ổ CẮM ĐA NĂNG + 2 CỔNG USB

Multi-standard Socket Module with Double USB Chargers (13A 250V)

80E725  **1.760.000**

80E725  -56  -26 **1.803.000**



### MODULE Ổ CẮM ĐÔI 2 CHẤU

Twin 2 Pin Socket Module (10A 250V)

80456  **248.000**

80456  -56  -26 **290.000**



### MODULE Ổ CẮM ĐƠN 3 CHẤU 16A

Single EU-US Socket with Earth Socket Module (16A 250V)

80487  **250.000**

80487  -56  -26 **293.000**



### MODULE Ổ CẮM SCHUKO

Schuko Socket Module (16A 250V)

80687  **358.000**

80687  -56  -26 **400.000**



### MODULE Ổ CẮM ĐA TIÊU CHUẨN

VỚI BỘ SẠC USB A+C

Multi-standard Socket Module with USB A+C Chargers

80E7252  **1.815.000**

80E7252  -56  -26 **1.858.000**

Module không bao gồm khung

MÀU SẮC

Trắng

Champagne -56

Đen -26

**HẠT TIVI, MẠNG, THOẠI & ĐIỀU KHIỂN**

TV, Data, Tel, Control and Regulator

**MODULE Ổ CẮM TIVI ĐƠN**

Tivi Outlet Module

80476  **231.000**80476  -56  -26 **274.000****MODULE Ổ CẮM TIVI ĐÔI**

Twin Tivi Outlet Module

80478  **309.000**80478  -56  -26 **352.000****MODULE Ổ CẮM ĐIỆN THOẠI ĐƠN (RJ11)**

Telephone Outlet Module (RJ11)

80480  **227.000**80480  -56  -26 **270.000****MODULE Ổ CẮM ĐIỆN THOẠI ĐÔI**

Twin Telephone Outlet Module (RJ11)

80488  **298.000**80488  -56  -26 **341.000****MODULE Ổ CẮM TIVI & ĐIỆN THOẠI (RJ11)**

Tivi and Telephone Outlet Module (RJ11)

80491  **298.000**80491  -56  -26 **341.000****MODULE Ổ CẮM TIVI & MẠNG (CAT6)**

Tivi and Data (RJ45) Outlet Module (Cat6)

80492  **501.000**80492  -56  -26 **543.000****MODULE Ổ CẮM MẠNG (CAT6)**

Data Outlet Module (Cat6)

80591  **363.000**80591  -56  -26 **406.000****MODULE Ổ CẮM MẠNG ĐÔI (CAT6)**

Twin Data Outlet Module (Cat6)

80593  **506.000**80593  -56  -26 **549.000****MODULE Ổ CẮM ĐIỆN THOẠI & MẠNG (CAT6)**

Telephone (RJ11) &amp; Data (RJ45) Outlet Module (Cat6)

80599  **480.000**80599  -56  -26 **523.000****MODULE CỔNG USB & HDMI**

USB-HDMI Outlet Module

80494  **732.000**80494  -56  -26 **774.000****MODULE Ổ CẮM KẾT NỐI TAI NGHE 3.5+VGA**

VGA-3.5 Earphone Outlet Module

80495  **710.000**80495  -56  -26 **752.000****MODULE Ổ CẮM KẾT NỐI ÂM THANH ĐƠN**

Speaker Socket Module

80800Y1  **294.000**80800Y1  -56  -26 **337.000****MODULE Ổ CẮM KẾT NỐI ÂM THANH ĐÔI**

Twin Speaker Socket Module

80800Y2  **443.000**80800Y2  -56  -26 **486.000****MODULE CHIẾT ÁP ĐÈN 0.85A-200W**

Dimmer Switch Module

80313  **766.000**80313  -56  -26 **809.000****MODULE CHIẾT ÁP QUẠT**

Fan regulator Switch Module

80317  **748.000**80317  -56  -26 **791.000**

## GIẢI PHÁP KHÁCH SẠN Hotel solutions



**MODULE CHUÔNG CỬA CÓ ĐÈN BÁO**  
**“KHÔNG LÀM PHIỀN” & “DỌN PHÒNG”**  
 Doorbell Switch Module “Do Not Disturb” & “Make Up Room” Indicator

80805  **1.221.000**  
 80805 -56 -26 **1.264.000**



**MODULE CÔNG TẮC KHẨN CẤP**  
 Emergency Switch Module

80809  **314.000**  
 80809 -56 -26 **356.000**



**MODULE CÔNG TẮC THẺ**  
 Keycard Switch Module

80526  **1.100.000**  
 80526 -56 -26 **1.143.000**



**MODULE CÔNG TẮC CHUÔNG CỬA V8 ELV**  
**(DC12V, 5 DÂY) (DND, MUR)**  
 V8 ELV doorbell switch Module(DC12V, 5-wire)(DND,MUR)

808051  **812.000**  
 808051 -56 -26 **855.000**



**MODULE CÔNG TẮC ĐÔI 2 CHIỀU HIỂN THỊ**  
**“KHÔNG LÀM PHIỀN” & “DỌN PHÒNG”**  
 2 Gang 2 Way Switch Module “Do Not Disturb” & “Make Up Room”

D80397  **286.000**  
 D80397 -56 -26 **329.000**



## VIÊN MẶT KÍNH Nature Frame (Crystal)



Crystal



Water



Black



Stone

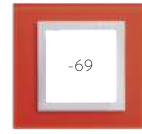

Orange

### VIÊN ĐƠN / ĐƠN / ĐÔI

1 Frame size M: 86 x 86 mm / 1 Frame size L: 102 x 95 mm / 2 Frame: 90 x 178 mm

80611	-30	-31	-63	-64	-69	(M)	<b>680.000</b>
80610	-30	-31	-63	-64	-69	(L)	<b>685.000</b>
80620	-30	-31	-63	-64	-69	(76 Type)	<b>1.179.000</b>

### VIÊN BA / BỐN / NĂM (76 Type)

(76 Type) 3 Frame: 90 x 254 mm / 4 Frame: 90 x 330 mm / 5 Frame: 90 x 406 mm

80630	-30	-31	-63	-64	-69		<b>1.676.000</b>
80640	-30	-31	-63	-64	-69		<b>2.219.000</b>
80650	-30	-31	-63	-64	-69		<b>2.738.000</b>

## VIÊN MẶT KIM LOẠI Classic Frame (Metal)



Silver



Gold

### VIÊN ĐÔI / BA / BỐN / NĂM (76 Type)

2 Frame: 86 x 162 / 3 Frame: 86 x 238 / 4 Frame: 90 x 314 / 5 Frame: 90 x 390 mm

80821	-42						<b>573.000</b>
80831	-42						<b>816.000</b>
80841	-42						<b>1.034.000</b>
80851	-42						<b>1.236.000</b>

### VIÊN ĐÔI / BA / BỐN / NĂM (76 Type)

2 Frame: 86 x 162 / 3 Frame: 86 x 238 / 4 Frame: 90 x 314 / 5 Frame: 90 x 390 mm

80821	-48						<b>606.000</b>
80831	-48						<b>860.000</b>
80841	-48						<b>1.090.000</b>
80851	-48						<b>1.370.000</b>

### VIÊN ĐƠN (86 Type)

(86 Type) 1 Frame: 86 x 86 mm

80811	-42						<b>351.000</b>
80811	-48						<b>366.000</b>

### VIÊN ĐÔI (86 Type)

(86 Type) 2 Frame: 86 x 172 mm

80822	-42						<b>965.000</b>
80822	-48						<b>965.000</b>

### VIÊN BA / BỐN / NĂM (86 Type)

(86 Type) 3 Frame: 86x258 mm / 3 Frame: 86x344 mm / 5 frame: 86x430 mm

80832	-42						<b>1.318.000</b>
80842	-42						<b>1.862.000</b>
80852	-42						<b>2.228.000</b>

### VIÊN BA / BỐN / NĂM (86 Type)

(86 Type) 3 Frame: 86x258 mm / 3 Frame: 86x344 mm / 5 frame: 86x430 mm

80832	-48						<b>1.318.000</b>
80842	-48						<b>1.862.000</b>
80852	-48						<b>2.228.000</b>

## VIÊN MẶT ĐÁ Stone Frame



Basaltic Black



Zaha Stone



Karakatagin

### VIÊN ĐƠN / ĐÔI / BA

1 Frame: 95 x 102 mm / 2 Frame: 95 x 178 mm / 3 Frame: 95 x 254 mm

80716	-2A	-2B					<b>2.068.000</b>
80726	-2A	-2B					<b>3.135.000</b>
80736	-2A	-2B					<b>4.345.000</b>

### VIÊN ĐƠN / ĐÔI / BA

1 Frame: 95 x 102 mm / 2 Frame: 95 x 178 mm / 3 Frame: 95 x 254 mm

80716	-2C						<b>2.112.000</b>
80726	-2C						<b>3.190.000</b>
80736	-2C						<b>4.488.000</b>

## VIÊN MẶT NHỰA Basic Frame (Plastic)



White



Cream champagne



Graphite black

### VIÊN ĐƠN / ĐÔI

1 Frame: 90 x 86 mm / (76 Type) 2 Frame: 90 x 162 mm

80810	<input type="checkbox"/>	86.000
80820	<input type="checkbox"/> (76 Type)	123.000

### VIÊN ĐƠN / ĐÔI

1 Frame: 90 x 86 mm / (76 Type) 2 Frame: 90 x 162 mm

80810	<input type="checkbox"/> -56	129.000
80820	<input type="checkbox"/> -56	166.000

### VIÊN BA / BỐN / NĂM (76 Type)

(76 Type) 3 Frame: 90x238 mm / 4 Frame: 90x314 mm / 5 Frame: 90x390 mm

80830	<input type="checkbox"/>	156.000
80840	<input type="checkbox"/>	216.000
80850	<input type="checkbox"/>	259.000

### VIÊN BA / BỐN / NĂM

(76 Type) 3 Frame: 90x238 mm / 4 Frame: 90x314 mm / 5 Frame: 90x390 mm

80830	<input type="checkbox"/> -56	199.000
80840	<input type="checkbox"/> -56	259.000
80850	<input type="checkbox"/> -56	301.000

## VIÊN CÔNG TẮC THẺ Key Card Frame



Crystal



Water



Black



Stone



Orange



White



Silver



Gold

### VIÊN CÔNG TẮC THẺ KÍNH

80612 Frame size L: 102 x 95 mm

80612	<input type="checkbox"/> -30	<input type="checkbox"/> -31	<input type="checkbox"/> -63	<input type="checkbox"/> -64	<input type="checkbox"/> -69	799.000
-------	------------------------------	------------------------------	------------------------------	------------------------------	------------------------------	---------

### VIÊN CÔNG TẮC THẺ KÍNH

80613 Frame size M: 86 x 86 mm

80613	<input type="checkbox"/> -30	<input type="checkbox"/> -31	<input type="checkbox"/> -63	<input type="checkbox"/> -64	<input type="checkbox"/> -69	799.000
-------	------------------------------	------------------------------	------------------------------	------------------------------	------------------------------	---------

### VIÊN CÔNG TẮC THẺ NHỰA

Frame: 86 x 86 mm

80813	<input type="checkbox"/>	180.000
-------	--------------------------	---------

### VIÊN CÔNG TẮC THẺ NHỰA

Frame: 86 x 86 mm

80813	<input type="checkbox"/> -56	<input type="checkbox"/> -26	223.000
-------	------------------------------	------------------------------	---------

### VIÊN CÔNG TẮC THẺ KIM LOẠI

Frame: 86 x 86 mm

80815	<input type="checkbox"/> -42	564.000
80815	<input type="checkbox"/> -48	626.000

# THIẾT BỊ KHÁC

## OTHERS

### TỦ APTOMAT Distribution Box



**SET65CS**



**SMX65CS**

	MÃ SẢN PHẨM	ĐƠN GIÁ	SỐ CỤC	SỐ HÀNG	KÍCH THƯỚC (mm)	LỖ KHOÉT (mm)	CHẤT LIỆU
<b>SET65CS</b>	<b>SET65CS-4AB</b>	<b>546.000</b>	4	1	150 x 198 x 100	140 x 195 x 90	Mặt tủ nhựa PC chống cháy Thân tủ thép sơn tĩnh điện
	<b>SET65CS-6AB</b>	<b>652.000</b>	6	1	186 x 198 x 100	175 x 195 x 90	
	<b>SET65CS-9AB</b>	<b>748.000</b>	9	1	241 x 200 x 102	230 x 195 x 90	
<b>SMX65CS</b>	<b>SMX65CS-4AB</b>	<b>546.000</b>	4	1	150 x 198 x 100	140 x 195 x 90	
	<b>SMX65CS-6AB</b>	<b>652.000</b>	6	1	186 x 198 x 100	175 x 195 x 90	
	<b>SMX65CS-9AB</b>	<b>748.000</b>	9	1	241 x 200 x 102	230 x 195 x 90	
	<b>SMX65CS-12AB</b>	<b>1.443.000</b>	12	1	320 x 240 x 112	295 x 215 x 90	
	<b>SMX65CS-15AB</b>	<b>1.687.000</b>	15	1	370 x 260 x 112	355 x 245 x 90	
	<b>SMX65CS-18AB</b>	<b>1.883.000</b>	18	1	424 x 260 x 112	405 x 225 x 90	
	<b>SMX65CS-21AB</b>	<b>2.077.000</b>	21	1	477 x 260 x 112	460 x 225 x 90	
	<b>SMX65CS-26AB</b>	<b>2.851.000</b>	26	2	405 x 321 x 115	385 x 305 x 90	
	<b>SMX65CS-32AB</b>	<b>3.312.000</b>	32	2	405 x 375 x 115	385 x 360 x 90	
<b>SMX65CS-42AB</b>	<b>4.024.000</b>	42	2	465 x 404 x 115	450 x 385 x 90		

## APTOMAT - DÒNG CẮT 6000A MCB



APTOMAT DÒNG CẮT 6000A 1P+N  
MCB 6000A 1P+N

SMB65C-40C10	<b>293.000</b>	SMB65C-40C20	<b>293.000</b>	SMB65C-40C32	<b>293.000</b>
SMB65C-40C16	<b>293.000</b>	SMB65C-40C25	<b>293.000</b>	SMB65C-40C40	<b>336.000</b>



APTOMAT DÒNG CẮT 6000A 1P  
MCB 6000A 1P

SMB65C-63C10	<b>155.000</b>	SMB65C-63C20	<b>155.000</b>	SMB65C-63C40	<b>200.000</b>
SMB65C-63C16	<b>155.000</b>	SMB65C-63C25	<b>155.000</b>	SMB65C-63C50	<b>204.000</b>
		SMB65C-63C32	<b>155.000</b>	SMB65C-63C63	<b>204.000</b>



APTOMAT DÒNG CẮT 6000A 2P

MCB 6000A 2P

SMB65C-63C16/2	<b>356.000</b>	SMB65C-63C32/2	<b>356.000</b>	SMB65C-63C63/2	<b>496.000</b>
SMB65C-63C20/2	<b>356.000</b>	SMB65C-63C40/2	<b>403.000</b>	SMB65C-100C80/2	<b>1.208.000</b>
SMB65C-63C25/2	<b>356.000</b>	SMB65C-63C50/2	<b>496.000</b>	SMB65C-100C100/2	<b>1.274.000</b>



APTOMAT DÒNG CẮT 6000A 3P

MCB 6000A 3P

SMB65C-63C16/3	<b>537.000</b>	SMB65C-63C32/3	<b>537.000</b>	SMB65C-63C63/3	<b>700.000</b>
SMB65C-63C20/3	<b>537.000</b>	SMB65C-63C40/3	<b>596.000</b>	SMB65C-100C80/3	<b>1.771.000</b>
SMB65C-63C25/3	<b>537.000</b>	SMB65C-63C50/3	<b>700.000</b>	SMB65C-100C100/3	<b>1.807.000</b>



APTOMAT DÒNG CẮT 6000A 4P

MCB 6000A 4P

SMB65C-63C16/4	<b>787.000</b>	SMB65C-63C32/4	<b>787.000</b>	SMB65C-63C63/4	<b>975.000</b>
SMB65C-63C20/4	<b>787.000</b>	SMB65C-63C40/4	<b>821.000</b>	SMB65C-100C80/4	<b>2.554.000</b>
SMB65C-63C25/4	<b>787.000</b>	SMB65C-63C50/4	<b>975.000</b>	SMB65C-100C100/4	<b>2.681.000</b>



APTOMAT CHỐNG GIẬT 30mA 6000A 1P+N  
RCBO 30mA 6000A 1P+N

SMB65CL-40C10	<b>1.026.000</b>	SMB65CL-40C20	<b>1.026.000</b>	SMB65CL-40C32	<b>1.026.000</b>
SMB65CL-40C16	<b>1.026.000</b>	SMB65CL-40C25	<b>1.026.000</b>	SMB65CL-40C40	<b>1.140.000</b>



APTOMAT CHỐNG GIẬT 30mA 6000A 2P  
RCBO 30mA 6000A 2P

SMB65CL-63C10/2	<b>1.130.000</b>	SMB65CL-63C20/2	<b>1.130.000</b>	SMB65CL-63C40/2	<b>1.420.000</b>
SMB65CL-63C16/2	<b>1.130.000</b>	SMB65CL-63C25/2	<b>1.164.000</b>	SMB65CL-63C50/2	<b>1.494.000</b>
		SMB65CL-63C32/2	<b>1.164.000</b>	SMB65CL-63C63/2	<b>1.494.000</b>



APTOMAT CHỐNG GIẬT 30mA 6000A 4P  
RCBO 30mA 6000A 4P

SMB65CL-63C63/4	<b>2.518.000</b>
-----------------	------------------

## ĐỀ ÂM Flush Mounting Boxes



### ĐỀ ÂM VUÔNG ĐƠN LOẠI 86

Multi Gang: All Simon family, except 76 type (i7/ V8)  
KT: 89.5 x 80.5 x 50 mm / 60 mm

SED1A086C **32.000**



### ĐỀ ÂM VUÔNG ĐƠN LOẠI 76

Multi Gang: i7/ V8 (76 Type)  
KT: 78 x 80 x 50 mm / 60 mm

SED1A076 **32.000**



### ĐỀ ÂM CHỮ NHẬT

118 Flush Mounting Box  
KT: 99.5 x 65 x 47.5 mm / 83.5 mm

SED1A118 **32.000**



### ĐỀ SẮT CHO Ổ ÂM SÀN

Pop-up Floor Socket Mounting Box  
KT: 100 x 100 x 50 mm / 84 mm

SED9A100 **158.000**

## BỘ CHUÔNG CỬA VỚI 2 ÂM THANH

Doorbell With Two Kinds of Sound



45002  **619.000**

45002  -73  -74 **658.000**

## HỘP CHỐNG THẨM Waterproof Cover



### HỘP CHỐNG THẨM NƯỚC VUÔNG

CHO CÔNG TẮC (NHỰA MỜ)  
Switch Waterproof Cover (V8 86 type cannot fit)

S154 **116.000**



### HỘP CHỐNG THẨM NƯỚC VUÔNG

CHO Ổ CẮM (NHỰA MỜ)  
Socket Waterproof Cover (V8 86 type cannot fit)

S155 **114.000**



### HỘP CHỐNG THẨM NƯỚC VUÔNG

CHO CÔNG TẮC (TRONG SUỐT)  
Switch Waterproof Transparent Cover  
(V8 86 type cannot fit)

S254 **207.000**



### HỘP CHỐNG THẨM NƯỚC VUÔNG

CHO Ổ CẮM (TRONG SUỐT)  
Socket Waterproof Transparent Cover  
(V8 86 type cannot fit)

S255 **204.000**



- CÓ KHẢ NĂNG CHỐNG BỤI HOÀN TOÀN
- BẢO VỆ TRƯỚC SỰ XÂM NHẬP CỦA NƯỚC



### MẶT CHE NƯỚC IP55 VUÔNG

CHO Ổ CẮM  
IP55 Socket Waterproof Cover

S258 **218.000**



### HỘP CHỐNG THẨM NƯỚC CHỮ NHẬT

(LOẠI NGANG)  
Waterproof Cover (Horizontal) (No hole for plug wires)

52154 **127.000**



### HỘP CHỐNG THẨM NƯỚC CHỮ NHẬT

CHO Ổ CẮM (LOẠI DỌC)  
Waterproof Cover (Vertical) (No hole for plug wires)

52155 **127.000**

## Ổ CẮM ÂM SÀN Floor Sockets



**2 Ổ CẮM 3 CHẤU ĐA NĂNG 10A**  
Floor Socket Twin Multi-standard

SEF3770  **1.860.000**  
SEF5770  **1.860.000**



**2 Ổ CẮM 3 CHẤU THƯỜNG 16A**  
Floor Socket Twin EU-US Socket

SEF3600  **1.833.000**  
SEF5600  **1.833.000**



**BỘ Ổ ĐIỆN THOẠI + TIVI**  
Floor Socket With Telephone + Tivi

SEF34P5  **1.819.000**  
SEF54P5  **1.819.000**



**BỘ Ổ ĐIỆN THOẠI + Ổ MẠNG (CAT6)**  
Floor Socket With Telephone + Data (Cat6)

SEF34P8  **1.845.000**  
SEF54P8  **1.857.000**



**BỘ Ổ MẠNG (CAT6) + Ổ TIVI**  
Floor Socket With Data (Cat6) + Tivi

SEF38P5  **1.813.000**  
SEF58P5  **1.813.000**



**BỘ 2 Ổ ĐIỆN THOẠI + Ổ TIVI**  
Floor Socket With Dual Telephone + Tivi

SEF3445  **1.797.000**  
SEF5445  **1.801.000**



**Ổ ĐƠN 3 CHẤU ĐA NĂNG + Ổ 2 CHẤU 10A/16A**  
Floor Socket With Multi-Standard + Two Pin

SEF3701  **1.793.000**  
SEF5701  **1.783.000**



**Ổ ĐƠN 3 CHẤU ĐA NĂNG + Ổ MẠNG 10A**  
Floor Socket With Multi-Standard + Data

SEF3708  **1.819.000**  
SEF5708  **1.819.000**



**Ổ ĐƠN 3 CHẤU ĐA NĂNG + Ổ ĐIỆN THOẠI 10A**  
Floor Socket With Multi-Standard + Telephone

SEF3704  **1.822.000**  
SEF5704  **1.816.000**





**Ổ MẠNG + ĐIỆN THOẠI + TIVI**  
Floor Socket With Data + Tivi + Telephone

SEF3845  **1.840.000**  
SEF5845  **1.840.000**





**Ổ ĐƠN 2 CHẤU + CỔNG USB ĐÔI 16A**  
Floor Socket With Two Pin Socket + Double USB

SEF31U0  **1.872.000**  
SEF51U0  **1.872.000**



**BỘ 2 Ổ MẠNG (CAT6)**  
Floor Socket With Dual Data (Cat6)

SEF38P8  **1.840.000**  
SEF58P8  **1.840.000**

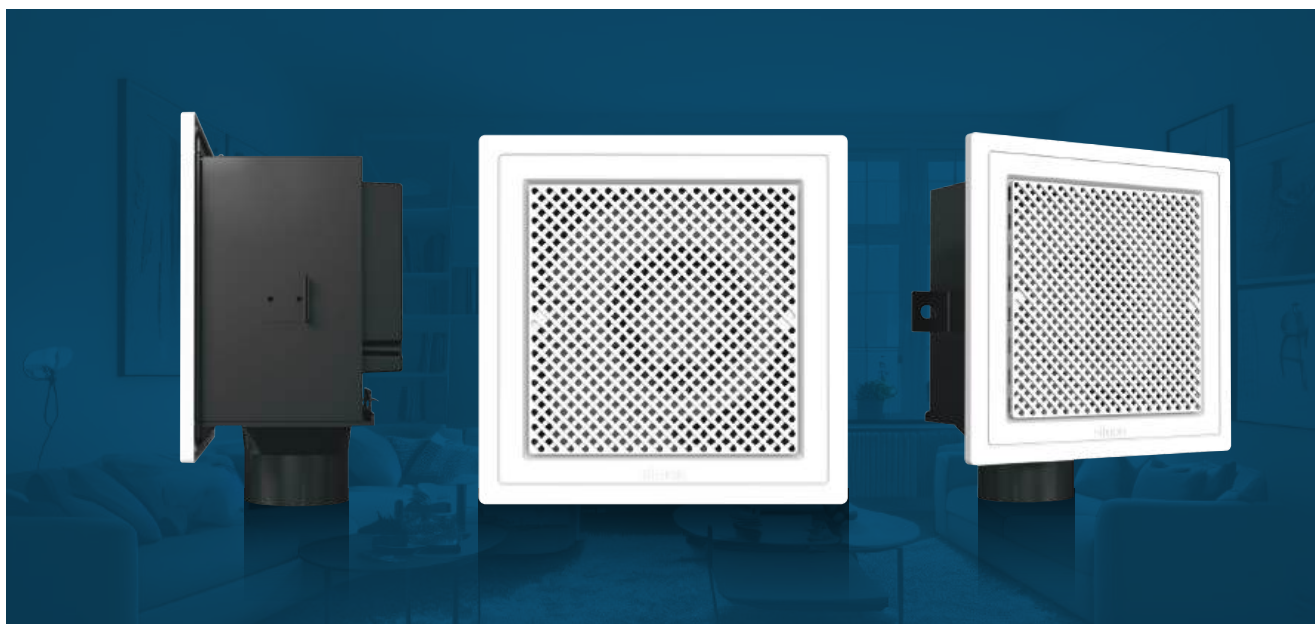

## QUẠT THÔNG GIÓ ÂM TRẦN LY TÂM Centrifugal Ceiling Fan

MÃ SẢN PHẨM	ĐƠN GIÁ (VNĐ)	ĐIỆN ÁP/ TẦN SỐ ĐỊNH MỨC	CÔNG SUẤT (W)	HỆ SỐ PF	LUU LƯỢNG GIÓ (m <sup>3</sup> /h)	TỐC ĐỘ (RPM)	ÁP SUẤT ĐÁY (Pa)	ĐỘ ỒN (dB)
<b>SEQ16W</b>	<b>3.570.000</b>	220V-240V/50Hz	16	0.9	190	820	105	36
<b>SEQ20W</b>	<b>4.204.000</b>	220V-240V/50Hz	20	0.9	220	920	110	40

### KÍCH THƯỚC BỀ NGOÀI LẮP ĐẶT

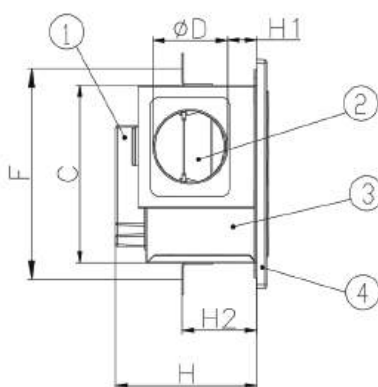
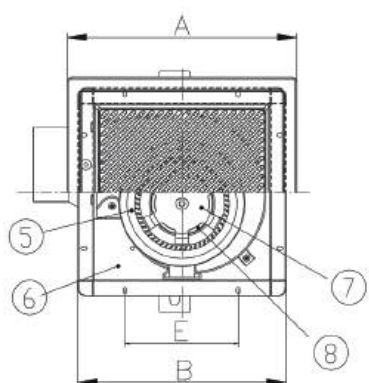

### CHÚ THÍCH

- 1 Hộp đựng động cơ, dây điện
- 2 Ống dẫn phụ
- 3 Thân quạt
- 4 Nắp quạt
- 5 Ống dẫn hướng gió
- 6 Tâm đế
- 7 Cánh quạt
- 8 Động cơ

### KÍCH THƯỚC LẮP ĐẶT QUẠT THÔNG GIÓ ÂM TRẦN LY TÂM (mm)

A	B	C	D	E	F	H	H1	H2	KÍCH THƯỚC LỖ KHOÉT (mm)
298	270	230	100	140	275	185	35	93	240x240

# GIẤY CHỨNG NHẬN



COMMISSION FOR THE STANDARDS, METROLOGY AND QUALITY OF VIET NAM (STAMEQ)  
VIETNAM CERTIFICATION CENTRE (QUACERT)



## CERTIFICATE

This is to certify that the Environmental Management System of

**SIMON ELECTRIC VIET NAM JOINT STOCK COMPANY**

Applicable location: Lot C006, Yen My II Industrial Park, Yen My Town, Yen My District, Hung Yen Province, Vietnam

Has been assessed and found to conform with the requirements of the following standard

**TCVN ISO 14001:2015 / ISO 14001:2015**

Certification Scope: Manufacturing LED lights, switches, electrical sockets, electrical components and lighting components; Manufacturing and trading of PPR and PVC pipes and pipe fittings; Trading of household appliances and lights

Certificate Number: **MT 525.25.24**

The validity of this Certificate: **from 29 May 2025 to 28 May 2028**

Original Certification: **29 May 2025**



*Nguyễn Tuấn Anh*  
PHÓ GIÁM ĐỐC

QUACERT - 8 Hoàng Quốc Việt, Nghĩa Đô Ward, Cầu Giấy Dist, Hà Nội, Viet Nam  
The validity of this certificate can be checked at website: [www.quacert.gov.vn](http://www.quacert.gov.vn) and [www.jas-anz.org/registrar](http://www.jas-anz.org/registrar)

COMMISSION FOR THE STANDARDS, METROLOGY AND QUALITY OF VIET NAM (STAMEQ)  
VIETNAM CERTIFICATION CENTRE (QUACERT)



## CERTIFICATE

This is to certify that the Quality Management System of

**SIMON ELECTRIC VIETNAM JOINT STOCK COMPANY**

Lot C006, Yen My II Industrial Park, Yen My town, Yen My district, Hung Yen province, Vietnam.

Has been assessed and found to conform with the requirements of the following standard

**TCVN ISO 9001:2015 / ISO 9001:2015**

Certification Scope: Manufacturing and supplying LED lights, switches, electrical sockets, electrical components and lighting components; Manufacturing and trading of pipes and pipe fittings PPR, PVC; Trading electrical equipment, lights and household appliances

Certificate Number: **HT 4639/V.25.19**

The validity of this Certificate: **from 27 April 2025 to 26 April 2028**

Original Certification: **27 April 2022**



*Nguyễn Tuấn Anh*  
PHÓ GIÁM ĐỐC

QUACERT - 8 Hoàng Quốc Việt, Nghĩa Đô Ward, Cầu Giấy Dist, Hà Nội, Viet Nam  
The validity of this certificate can be checked at website: [www.quacert.gov.vn](http://www.quacert.gov.vn) and [www.jas-anz.org/registrar](http://www.jas-anz.org/registrar)

**Phúc Gia** CÔNG TY CỔ PHẦN PHÒNG THỬ NGHIỆM PHÚC GIA  
TRUNG TÂM CHỨNG NHẬN PHÚC GIA

## GIẤY CHỨNG NHẬN/ CERTIFICATE

Số/ No.: PGC-QC19-S050-240923  
(Mã số/ Code: LED-S050)

Chứng nhận sản phẩm/ Certification for the product:  
Theo Phụ lục - Danh mục sản phẩm được chứng nhận kèm theo/  
According to the Annex - Certified product list attached

Được sản xuất và nhập khẩu bởi/ Manufactured and imported by:  
**CÔNG TY CỔ PHẦN THIẾT BỊ ĐIỆN SIMON VIỆT NAM**  
Địa chỉ/ Address: Lô CN06, KCN Yên Mỹ II, thị trấn Yên Mỹ, huyện Yên Mỹ, tỉnh Hưng Yên, Việt Nam.

Phù hợp với Quy chuẩn Kỹ thuật Quốc gia/ Conforms to National Technical Regulations:  
**QCVN 19:2019/BKHCN**  
được phép sử dụng dấu hợp quy (CR)<sup>(\*)</sup>/ permitted to use regulation marks (CR)<sup>(\*)</sup>

Phương thức chứng nhận/ Certification method:  
**Phương thức 1/ Method 1**  
(Thông tư số 28/2012/TT-BKHCN ngày 12/12/2012 và Thông tư số 02/2017/TT-BKHCN ngày 31/03/2017 của Bộ Khoa học và Công nghệ/ Circular No. 28/2012/TT-BKHCN dated December 12, 2012 and Circular No. 02/2017/TT-BKHCN dated March 31, 2017 of the Ministry of Science and Technology)

Ngày cấp chứng nhận/ Date of issue: 29/11/2024  
Ngày hết hiệu lực/ Expiration date: 28/11/2027

(\*) Dấu hợp quy/  
Regulation marks

**KT. TỔNG GIÁM ĐỐC  
GIÁM ĐỐC TRUNG TÂM  
CHỨNG NHẬN PHÚC GIA.**

*Lê Mạnh Tiến*

PASS: r7wbeih





Chú ý: Sản phẩm được chứng nhận này chỉ được sử dụng để chứng minh sự phù hợp của sản phẩm với yêu cầu của quy chuẩn kỹ thuật quốc gia. Hệ thống chứng nhận này không phải là một phần của quy trình sản xuất. Mọi chi tiết xin liên hệ: Hotline: 0982 200 000 - 097 7777 0000. Email: info@phucgia.com.vn

**Phúc Gia** CÔNG TY CỔ PHẦN PHÒNG THỬ NGHIỆM PHÚC GIA  
TRUNG TÂM CHỨNG NHẬN PHÚC GIA

## GIẤY CHỨNG NHẬN/ CERTIFICATE

Số/ No.: PGC-QC19-S050-240806  
(Mã số/ Code: LED-S050)

Chứng nhận sản phẩm/ Certification for the product:  
Theo Phụ lục - Danh mục sản phẩm được chứng nhận kèm theo/  
According to the Annex - Certified product list attached

Được phân phối bởi/ Distributed by:  
**CÔNG TY CỔ PHẦN THIẾT BỊ ĐIỆN SIMON VIỆT NAM**  
Địa chỉ/ Address: Lô CN06, KCN Yên Mỹ II, thị trấn Yên Mỹ, huyện Yên Mỹ, tỉnh Hưng Yên, Việt Nam.

Phù hợp với Quy chuẩn Kỹ thuật Quốc gia/ Conforms to National Technical Regulations:  
**QCVN 19:2019/BKHCN**  
được phép sử dụng dấu hợp quy (CR)<sup>(\*)</sup>/ permitted to use regulation marks (CR)<sup>(\*)</sup>

Phương thức chứng nhận/ Certification method:  
**Phương thức 1/ Method 1**  
(Thông tư số 28/2012/TT-BKHCN ngày 12/12/2012 và Thông tư số 02/2017/TT-BKHCN ngày 31/03/2017 của Bộ Khoa học và Công nghệ/ Circular No. 28/2012/TT-BKHCN dated December 12, 2012 and Circular No. 02/2017/TT-BKHCN dated March 31, 2017 of the Ministry of Science and Technology)

Ngày cấp chứng nhận/ Date of issue: 17/9/2024  
Ngày hết hiệu lực/ Expiration date: 16/9/2027

(\*) Dấu hợp quy/  
Regulation marks

**KT. TỔNG GIÁM ĐỐC  
GIÁM ĐỐC TRUNG TÂM  
CHỨNG NHẬN PHÚC GIA.**

*Lê Mạnh Tiến*

PASS: cshzysih





Chú ý: Sản phẩm được chứng nhận này chỉ được sử dụng để chứng minh sự phù hợp của sản phẩm với yêu cầu của quy chuẩn kỹ thuật quốc gia. Hệ thống chứng nhận này không phải là một phần của quy trình sản xuất. Mọi chi tiết xin liên hệ: Hotline: 0982 200 000 - 097 7777 0000. Email: info@phucgia.com.vn



## Simon là tập đoàn công nghiệp với LỊCH SỬ PHÁT TRIỂN HƠN 100 NĂM

Simon là tập đoàn công nghiệp chuyên về các giải pháp công nghệ chiếu sáng, điều khiển ánh sáng, thiết bị kết nối và thiết bị điện, được thành lập vào năm 1916, có trụ sở chính tại thành phố Barcelona, Tây Ban Nha.

Trải qua hơn 100 năm hình thành và phát triển, hiện Simon đã có mặt tại hơn 90 Quốc gia với 15 nhà máy sản xuất và trụ sở tại 16 Quốc gia trên thế giới

**CTY CP THIẾT BỊ ĐIỆN SIMON VIỆT NAM**

Nhà Máy: Lô CN06, KCN Yên Mỹ II, Xã Yên Mỹ, Tỉnh Hưng Yên



**0968 111 900**

### **VĂN PHÒNG HÀ NỘI**

ĐC: Tầng 5, Tòa nhà C Plus Office, Đường Thành Thái,  
Tổ 28, Phường Cầu Giấy, TP. Hà Nội

### **VĂN PHÒNG ĐÀ NẴNG**

ĐC: Số 40 Hoàng Văn Thái, Phường Hòa Khánh,  
TP. Đà Nẵng

### **VĂN PHÒNG HỒ CHÍ MINH**

ĐC: Tầng 4, Tòa nhà Y12 Hồng Lĩnh, Cư Xá Bắc Hải,  
Phường Hòa Hưng, TP. Hồ Chí Minh